

**PRD Series Power Relay**

- Contact ratings to 50 amps
- Magnetic blowouts available for switching DC loads
- Contact arrangement up to 2 form C (2CO)
- 1 Form C auxiliary switch available
- UL class B insulation

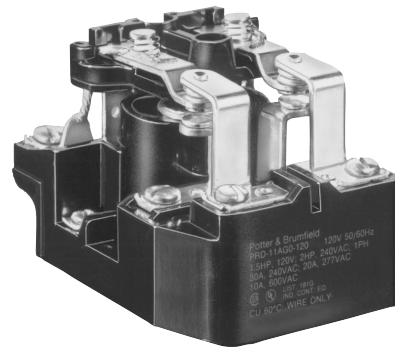

Typical applications  
Industrial controls, lighting

**Approvals**

UL E22575; CSA LR15734; VDE Reg.Nr.C144  
Models with all screw terminals are UL Listed. Others are UL Recognized.  
Technical data of approved types on request

**Contact Data**

Contact arrangement	1 and 2 Form A (NO); 1 and 2 Form C (CO); 1 Form X (NO-DM)
Rated voltage	600VAC, 125VDC
Rated current	50A
Contact material	Ag, AgCdO, W
Min. recommended contact load	1A, 12VDC or 12VAC
Initial contact resistance	75mΩ Max
Initial voltage drop	75mV
Frequency of operation	7200 ops/hr
Operate/releases time max.	40/20ms
Bounce time max.	10ms

**Contact ratings**

Type	Load	Cycles
<b>UL 508 <sup>1)</sup></b>		
Models with screws or quick connects for main terminals		
Code Y, Ag, 1 pole		
	25A, 277VAC	100x10 <sup>3</sup>
	1HP, 120VAC	100x10 <sup>3</sup>
	2HP, 250VAC	100x10 <sup>3</sup>
	10A, 600VAC	100x10 <sup>3</sup>
	7A, 50VDC, resistive	100x10 <sup>3</sup>
Code Y, Ag, 2 pole		
	25A, 240VAC	100x10 <sup>3</sup>
	20A, 277VAC	100x10 <sup>3</sup>
	1HP, 120VAC	100x10 <sup>3</sup>
	2HP, 250VAC	100x10 <sup>3</sup>
	7A, 50VDC, resistive	100x10 <sup>3</sup>
	10A, 600VAC	100x10 <sup>3</sup>
Code G, AgCdO, 1 pole		
	30A, 277VAC, resistive	100x10 <sup>3</sup>
	1.5HP, 120VAC	100x10 <sup>3</sup>
	2HP, 250VAC	100x10 <sup>3</sup>
	10A, 600VAC	100x10 <sup>3</sup>
Code G, AgCdO, 2 pole		
	30A, 240VAC	100x10 <sup>3</sup>
	20A, 277VAC	100x10 <sup>3</sup>
	1.5HP, 120VAC	100x10 <sup>3</sup>
	2HP, 250VAC	100x10 <sup>3</sup>
	10A, 600VAC	100x10 <sup>3</sup>

1) Any PRD relay deviating electrically or physically from the standard models in the table is not UL or CSA listed. All horsepower ratings are for single phase motors..

**Contact ratings (continued)**

Type	Load	Cycles
<b>UL 508 <sup>1)</sup></b>		
Models with screws or quick connects for main terminals		
Code F, AgCdO, 1 pole		
	50A, 240VAC, general purpose <sup>2)</sup>	20x10 <sup>3</sup>
	30A, 277VAC, resistive	100x10 <sup>3</sup>
	1.5HP, 120VAC	100x10 <sup>3</sup>
	2HP, 250VAC	100x10 <sup>3</sup>
	10A, 600VAC	100x10 <sup>3</sup>
Code F, AgCdO, 2 pole		
	50A, 240VAC, general purpose <sup>2)</sup>	20x10 <sup>3</sup>
	30A, 240VAC	100x10 <sup>3</sup>
	20A, 277VAC	100x10 <sup>3</sup>
	1.5HP, 120VAC	100x10 <sup>3</sup>
	2HP, 250VAC	100x10 <sup>3</sup>
	10A, 600VAC	100x10 <sup>3</sup>
Code H, Ag with magnetic blowout, 1 or 2 pole		
	20A, 125VDC	100x10 <sup>3</sup>
	1/3HP, 125VDC	100x10 <sup>3</sup>
Code J, AgCdO with magnetic blowout, 1 or 2 pole		
	20A, 125VDC	100x10 <sup>3</sup>
	1/3HP, 125VDC	100x10 <sup>3</sup>
Code N, W stationary with AgCdO movable, 1 or 2 pole		
	25A, 250VAC	100x10 <sup>3</sup>
	1HP, 125VAC	100x10 <sup>3</sup>
	2HP, 250VAC	100x10 <sup>3</sup>

2) In order to achieve 50A rating with Contact Code F, Termination Code 0 or A is required.

<b>UL 508 <sup>1)</sup></b>		
Models with box lugs for main terminals		
Code P, Ag, 1 form X		
	50A, 277VAC, general purpose	100x10 <sup>3</sup>
	30A, 277VAC, ballast	6x10 <sup>3</sup>
	15A, 277VAC, tungsten	6x10 <sup>3</sup>
	102LRA, 17FLA, 240VAC	30x10 <sup>3</sup>
	120LRA, 20FLA, 120VAC	30x10 <sup>3</sup>
	1.5HP, 120VAC	30x10 <sup>3</sup>
	3HP, 240VAC	30x10 <sup>3</sup>

**Factory ratings**

Models with box lugs for main terminals		
Code R, Ag with magnetic blowout, 1 form X		
	60A, 28VDC, resistive	100x10 <sup>3</sup>
	30A, 125VDC	100x10 <sup>3</sup>

Mechanical endurance DC Coil, 1x10<sup>6</sup> ops.; AC Coil 5x10<sup>5</sup> ops.

**Auxiliary Snap-Action Switch Contact Data**

Contact arrangement	1 Form C (CO)
Rating	5A, 120VAC, 60 Hz., 25°C
Contact material	Ag

**PRD Series Power Relay (Continued)**

**Coil Data**

Coil voltage range	6 to 110VDC 6 to 480VAC
Coil insulation system according UL	Class B

**Coil versions, DC coil**

Coil code	Rated voltage VDC	Operate voltage VDC	Release voltage VDC	Coil resistance $\Omega \pm 10\%$	Rated coil power W
6	6	4.5	0.6	18	2
12	12	9	1.2	71	2
24	24	18	2.4	288	2
48	48	36	4.8	1150	2
110	110	82.5	11	6050	2

All figures are given for coil without preenergization, at ambient temperature +23°C.  
Other coil voltages on request.

**Coil versions, AC coil**

Coil code	Rated voltage VAC	Operate voltage VAC	Release voltage VAC	Coil resistance $\Omega \pm 15\%$	Rated coil power VA
6	6	5.1	0.6	0.86	9.8
12	12	10.2	1.2	3.2	9.8
24	24	20.4	2.4	12	9.8
120	120	102	12	290	9.8
240	240	204	24	1200	9.8
480	480	408	48	4500	9.8

All figures are given for coil without preenergization, at ambient temperature +23°C.  
Other coil voltages on request.

**Insulation Data**

Initial dielectric strength	
between open contacts	2000V <sub>rms</sub>
between contact and coil	2000V <sub>rms</sub>
between adjacent contacts	2000V <sub>rms</sub>
Initial insulation resistance	
between insulated elements	100M $\Omega$

**Other Data**

Material compliance: EU RoHS/ELV, China RoHS, REACH, Halogen content refer to the Product Compliance Support Center at [www.te.com/customer-support/rohssupportcenter](http://www.te.com/customer-support/rohssupportcenter).

Ambient temperature

AC coil: -55°C to 45°C  
DC coil: -55°C to 80°C

Category of environmental protection

IEC 61810 RT0 - open relay

Terminal type Screw, Quick connects, Box lugs

Weight 284g

Packaging/unit tray/20 pcs., box/40pcs.

**Accessories**

Product Code Description

35D013 Metal dust cover

**Dimensions**

PRD/PRDA 1, 3, 5 and 7

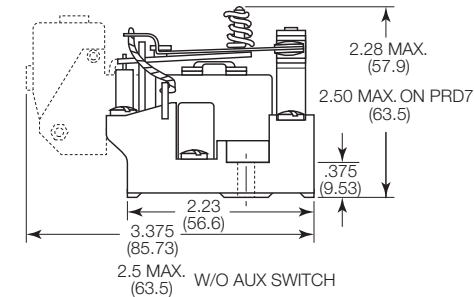
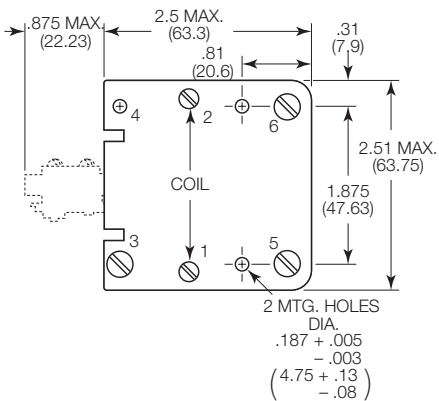

PRD/PRDA 11

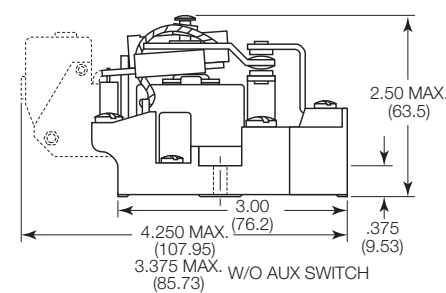
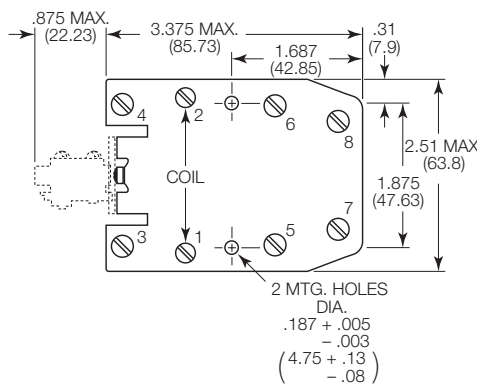

PRD-3\_P and R

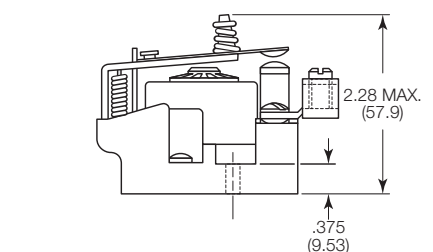
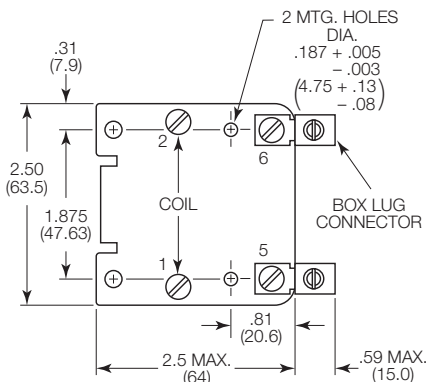

**PRD Series Power Relay (Continued)**

**Terminal assignment for models with magnetic blowout**

PRD3 with blowout

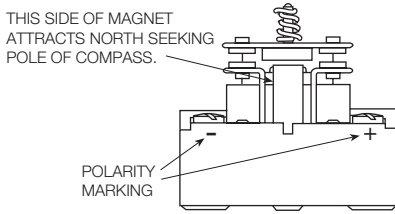

PRD7 with blowout

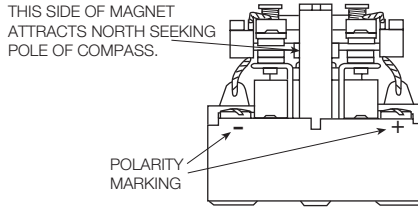

PRD 11 with blowout

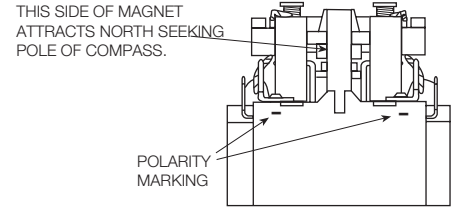

**Product code structure**

Typical product code

**PRD -7 A Y 0 -120**

**Type**

- PRD** Open relay
- PRDA** Open relay with aux. 1 form C (CO) snap-action switch

**Main contact arrangement**

- 1** 1 form A (1 NO)
- 5** 1 form C (1 CO)
- 7V** 2 form A (2 NO) with 3mm contact gap <sup>1)</sup>
- 3** 1 form X (1 NO-DM)
- 7** 2 form A (2 NO)
- 11** 2 form C (2 CO)

<sup>1)</sup> Code 7V is only available as a UL Recognized model, not UL Listed

**Coil input**

- A** AC, 50/60Hz
- D** DC

**Main contact material and type**

- Y** .312" (7.92mm) dia. Ag [25A max. rating]
- G** .312" (7.92mm) dia. AgCdO [30A max. rating]
- F** .312" (7.92mm) dia. AgCdO [50A max. rating] <sup>2)</sup>
- H** Ag with magnetic blowout [20A DC max. rating] <sup>3)</sup>
- J** AgCdO with magnetic blowout [20A DC max. rating]
- N** W stationary & AgCdO movable [25A max. rating] <sup>4)</sup>
- P** Ag [50A max. rating] <sup>5)</sup>
- R** Ag with magnetic blow out [50A max. rating] <sup>5)</sup>

<sup>2)</sup> Available with Main contact arrangement code (step 2 above) 1, 5, 7 or 11 only, and Termination code (step 5 below) 0 or A only.

<sup>3)</sup> Available with Main contact arrangement code (step 2 above) 3, 7 or 11 only

<sup>4)</sup> Available with Main contact arrangement code (step 2 above) 1, 5, 7 or 11 only.

<sup>5)</sup> Available with Main contact arrangement code (step 2 above) 3 only, and Termination code (step 5 below) 4 only.

**Termination**

**PRD types only**

- 0** #8-32 screw term. for main contacts, #6-32 screw term. for coil.
- 1** .250" (6.35mm) QC for main contacts and coil
- 3** #8-32 screw term. for main contacts, .250" (6.35mm) QC for coil.
- 4** Box lug term. which accept #6 - #14 wire for main contacts, #6-32 screw term. for coil. <sup>6)</sup>

<sup>6)</sup> Available with Main contact arrangement code (step 2 above) 3 only, and Main contact material code (step 4 above) P or R only.

**PRDA (with aux. switch) types only**

- A** #8-32 screw term. for main contacts, #6-32 screw term. for coil, screw term. for aux. switch
- B** .250" (6.35mm) QC for main contacts, coil and aux. switch
- L** Twin .250" (6.35mm) QC for main contacts, .250" (6.35mm) QC for coil and aux. switch

**Coil voltage**

Coil code: please refer to coil versions table

**PRD Series Power Relay (Continued)**

Product Code	Arrangement	Material	Coil	Terminals	Part Number		
PRD-3AY0-120	1 form X, 1 NO-DM	Ag	120VAC	Screw	7-1393127-9		
PRD-3AG0-120		AgCdO, 30A			6-1393127-9		
PRD-3AJ0-120		AgCdO, mag blowout			7-1393127-4		
PRD-3AJ3-24	1 form C, 1 CO	Ag, mag blowout	24VAC	Screw / QC	7-1393127-5		
PRD-3DH0-24			24VDC		8-1393127-6		
PRD-3DY0-12		Ag	12VDC	Screw	9-1393127-5		
PRD-3DY0-24			24VDC		9-1393127-6		
PRD-3DY0-110			110VDC		9-1393127-4		
PRD-5AY0-24				24VAC		1393128-6	
PRD-5AY0-120			120VAC		1393128-5		
PRD-5AY1-120	1 form C, 1 CO			QC	1-1393128-1		
PRD-5AY0-240				240VAC	Screw	1393128-7	
PRD-5DF0-12				12VDC		2-1423100-4	
PRD-5DY0-12	2 form A, 2 NO	Ag	24VDC	Screw / QC	1-1393128-6		
PRD-5DY0-24					1-1393128-7		
PRD-7AG0-120		AgCdO, 30A			120VAC	9-1393129-5	
PRD-7AY0-24		Ag	24VAC		1393130-9		
PRD-7AY0-120			120VAC		1393130-7		
PRD-7AY0-240			240VAC		1-1393130-0		
PRD-7AY3-120	2 form A, 2 NO	AgCdO, 30A	120VAC	Screw / QC	1-1393130-2		
PRD-7DG0-24			24VDC		1-1393130-6		
PRD-7DH0-48			Ag, mag blowout		48VAC	2-1393130-1	
PRD-7DY0-12		Ag	12VDC		2-1393130-8		
PRD-7DY0-24			24VDC		2-1393130-9		
PRD-11AF0-240		2 form C, 2 CO	AgCdO, 50A		240VAC		3-1423100-0
PRD-11AG0-24	AgCdO, 30A		24VAC	1-1393127-1			
PRD-11AG0-120			120VAC	1393127-9			
PRD-11AG0-240	2 form C, 2 CO	Ag, mag blowout	240VAC	Screw / QC	1-1393127-2		
PRD-11AH0-120			120VAC		1-1393127-6		
PRD-11AY0-24			Ag		24VAC	2-1393127-9	
PRD-11AY0-120			120VAC		2-1393127-6		
PRD-11AY0-240			240VAC		3-1393127-0		
PRD-11AY0-480			480VAC		3-1393127-1		
PRD-11DF0-12	2 form C, 2 CO	AgCdO, 50A	12VDC	Screw / QC	2-1423100-2		
PRD-11DF0-110			110VDC		2-1423100-9		
PRD-11DG0-12		AgCdO, 30A	12VDC		3-1393127-5		
PRD-11DG0-24			24VDC		3-1393127-8		
PRD-11DH0-12		Ag, mag blowout	12VDC		4-1393127-7		
PRD-11DH0-24			24VDC		4-1393127-9		
PRD-11DH0-48	2 form C, 2 CO			Screw / QC	5-1393127-0		
PRD-11DH0-110						110 VDC	4-1393127-6
PRD-11DJ0-24					AgCdO, mag blowout	24 VDC	5-1393127-5
PRD-11DY0-12		Ag	12 VDC		6-1393127-1		
PRD-11DY0-24			24 VDC		6-1393127-2		
PRD-11DY0-48			48 VAC		6-1393127-3		
PRD-11DY0-110	2 form C, 2 CO		110 VDC	Screw / QC	6-1393127-0		
PRDA-11AGA-120					AgCdO, 30A	120 VAC	7-1393131-4
PRDA-11AYA-120							7-1393131-9

**PRD accessory**

Product Code	Description	Part Number
35D013	Metal dust cover enclosure	5-1393158-2

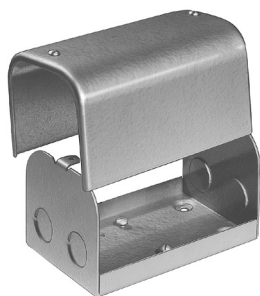

**35D013 Dust Cover**

PRD dust cover has a steel base with knockouts for 0.5" (12.7mm) dia. conduit and a cover fitted with two screws. Fits PRD relays, except with auxiliary contacts. Finished in gray baked enamel.

**Mounting:**  
Three No. 10 holes on 1.875" (47.63mm) x 4.125" (104.77mm) centers.

